

eleXtric

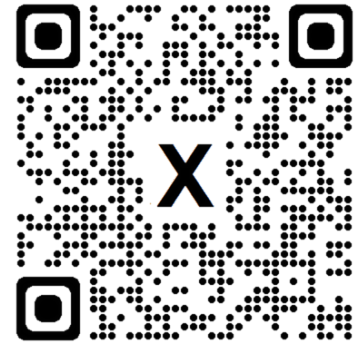

INSTALLATION AND USER MANUAL

WineMaster C25 / C25S(R) / C25X / C25S(R)X

To ensure a successful installation, please carefully read through this manual as it contains all necessary information to do so.

It is essential to have all of these conditions fulfilled prior to starting and to continue operating your unit correctly for many years.

If any assistance is needed, please reach out to Elextric Ltd via telephone (+44 020 3286 8525) or email (info@elextric.co.uk).



GB

User manual

Table of contents

1. CELLAR EQUIPMENT	5
1.1. Evacuation room	5
1.2. Cellar insulation	6
1.2.1 Insulation of wall, ceiling and floor	7
1.2.1.1. The door	8
1.2.3 Insulation of other elements	8
2. INSTALLATION OF WINE CONDITIONING UNIT WINEMASTER®	8
2.1 Wall drilling	
2.2 Sealing and wooden frame levelling	9
2.3 Fitting the air conditioner	10
2.3.1. Removing the plastic cover	10
2.3.2. Fitting the device into the wooden frame	11
2.3.3. Installing the water drain system	11
3. USING THE AIR CONDITIONER WINEMASTER®	13
3.2 Setting the temperature	13
3.3. Standby mode	14
3.4. Automatic defrost	14
4. MAINTENANCE OF THE AIRCONDITIONER WINEMASTER®	14
4.3. Replacing the filter	14
5. WARRANTY.....	15
5.1 Legal warranty	15
5.2 2 years contractual warranty	15
5.3 Warranty conditions	15
5.4 Exclusions and limitations of warranty	16

Introduction

Thank you for purchasing your WINEMASTER wine conditioning unit – we are sure it will provide excellent temperature control for your wine cellar, wine room, wine wall or wine cabinet.

WINEMASTER (formerly 'Fondis') has been established as the leader in temperature control for wine cellars for decades. Our engineering team is constantly testing the latest materials, technology and engineering processes to ensure you have the best product available.

The end result is all about you, the customer, enjoying your wine which is a delicate asset to own, preserve and store. We know this, and this is our specialty with the range of units we offer.



Technical data

	WINE C25 / C25S(R)/WINEC25X/WINEC25S(R)X
Weight	31 kg
Dimensions	540x380x525
Temperature setting	Preset at 13°C, adjustable between 11 & 25°C *
Maximum outside temperature	35°C **
Cooling power	550 W at 15°C **
Electric supply	235V-50 Hz + 3 m cable length
Electric power	400 W
Heating power	250 W (only for C25S(R)/WINEC25S(R)X)

The unit comes pre-wired with a 5amp plug top and can be connected to a fused spur either on a radial or ring circuit, provided that the electrical installation meets the BS7671 standards.

* The insulation quality and thickness has to be in accordance with the volume of the cellar and the set temperature.

** The cooling performance is dependant from the outside temperature. Therefore, the set temperature of 12°C for the cellar cannot be maintained if the outside temperature reaches the 35°C.

If the thermal safety functions to often, there is a risk for the compressor to be damaged. In all cases, **it must be avoid that the outside temperature remains at 35°C**, this high temperature should be limited to the summer period.

Technical drawing

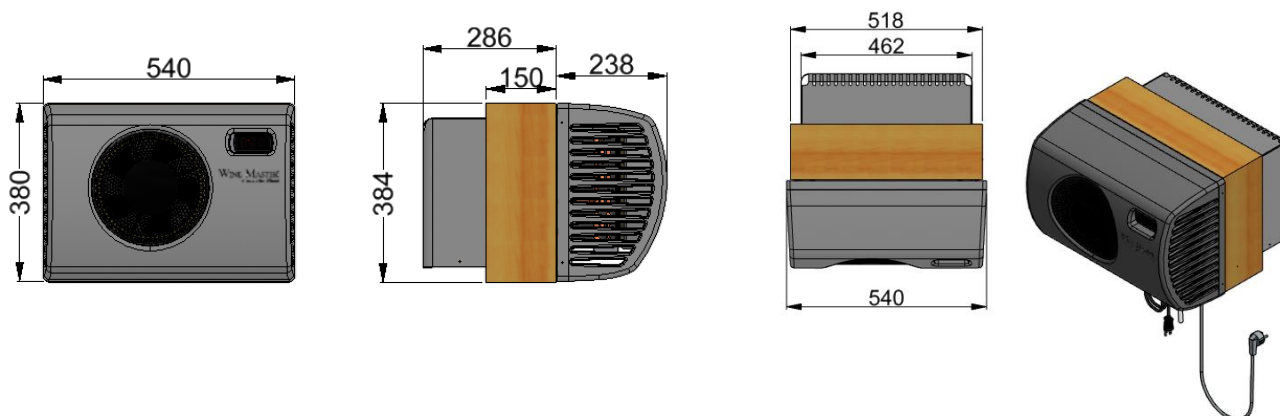

1. CELLAR EQUIPMENT

The air conditioner is built into the wall. For a correct functioning, the unit expels air at the outside to 20°C approx above the sucked temperature. This air must be cooled in a well ventilated room or evacuated outside.

1.1. Evacuation room

- The “hot “ side of the WINEMASTER must be inside a room (exceptionally, an outdoor installation is possible if the outside part is sheltered and protected from the weather (direct rain, snow, etc...).

→ For an outside installation, it is advisable to use WINE C25SR/WINEC25SRX

- Attention, starting the compressor at a temperature $\leq 0^{\circ}\text{C}$ will destroy it.

→ Never change the set temperature if the compressor is at a temperature of $\leq 0^{\circ}\text{C}$ (this specification doesn't concern the model SR equipped with a heating belt on the compressor).

The air conditioner WINEMASTER® evacuates hot air inside a room that must be well ventilated

- Maximum temperature and non permanent $\leq 35^{\circ}\text{C}$
- Ideal temperature $\approx 20^{\circ}\text{C}$

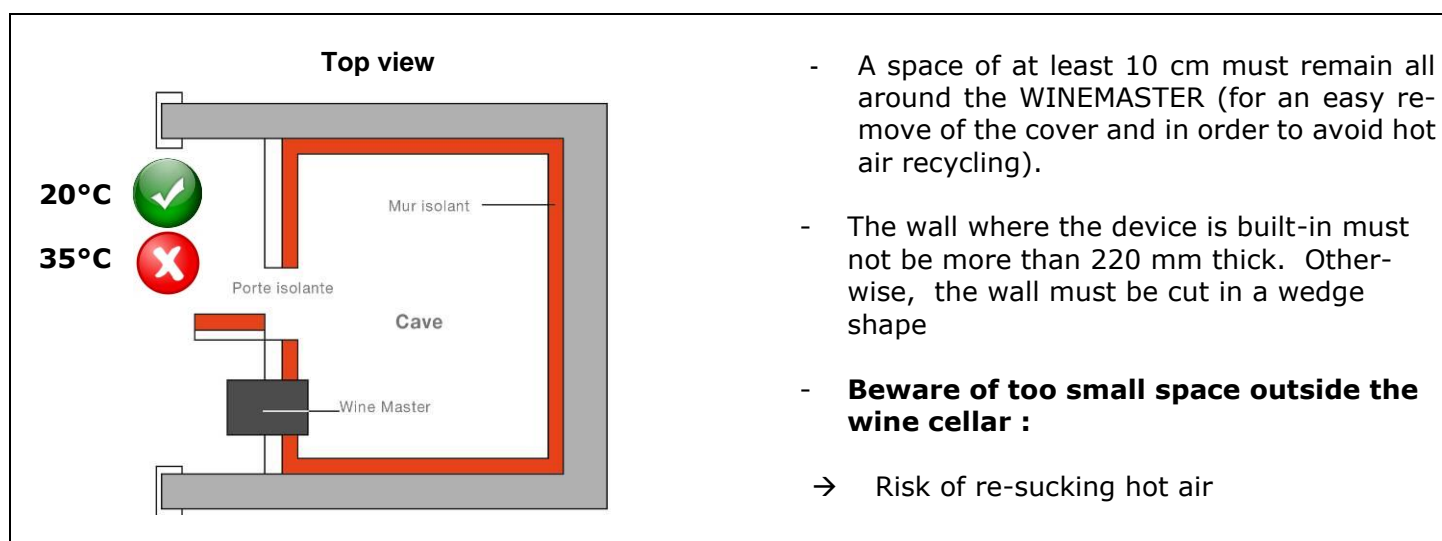

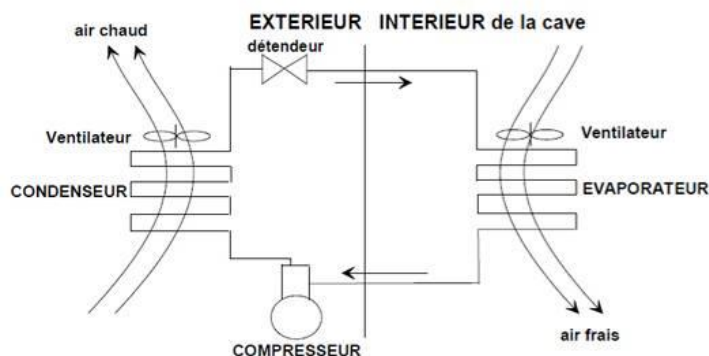
VENTILATED COLD OR « NO FROST »

The advantages of « ventilated cold »:

- No frost other than on the evaporator.
- Automatic defrosting and maximized refrigeration efficiency.
- Cold distribution improved by a permanent air circulation (without air stratification).
- The circulation of air allows maintaining the pre-selected temperature throughout the cellar.

1.2. Cellar insulation

Insulation is essential for efficient functioning of the WINEMASTER®. A good insulation enables to maintain a stable **temperature and humidity level**. The chart on the next page will allow you to determine the type and thickness of insulation needed in relation to the exterior volume of the cellar and model of the WINEMASTER®, for an inside temperature of 12°C.

Complete insulation

The insulating elements should be preferably :

- By « tongue and groove » panels or
- By panels fused together

→ **IMPORTANT: Avoid the intrusion of heat and humidity which can alter the functioning.**

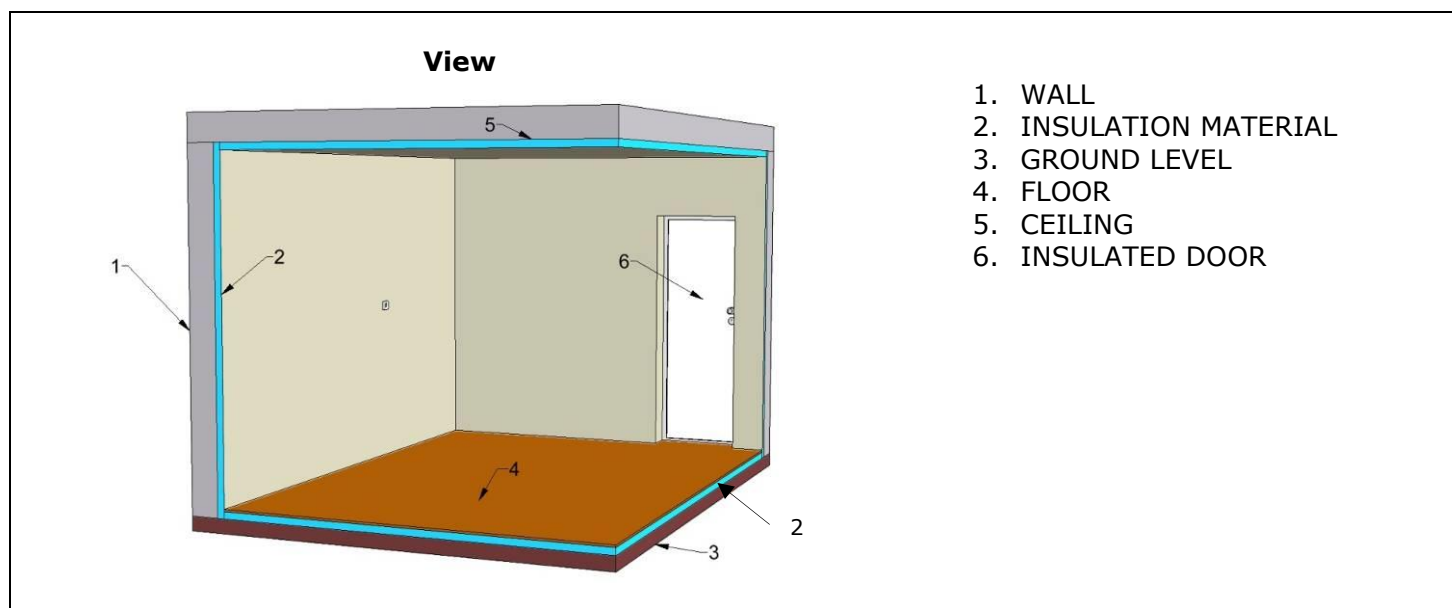

1. WALL
2. INSULATION MATERIAL
3. GROUND LEVEL
4. FLOOR
5. CEILING
6. INSULATED DOOR

IMPORTANT

The WINEMASTER® warranty is only valid if the insulation is in compliance with the board « Insulation selection » requirements for the whole cellar (walls, floor, door and ceiling) with perfect continuity of insulation and an installation in accordance to the user guide.

Insulation selection

Volume of the cellar (m ³)	Polystyrene expanded = 0,044 W/m°C (mm)	Polystyrene extruded = 0,030 W/m°C (mm)	Polyurethane foam = 0,025 W/m°C (mm)
6	40	30	30
8	50	40	30
10	60	40	40
12	70	50	40
14	70	50	40
16	80	60	50
18	90	60	50
20	90	70	60
22	100	70	60
24	110	70	60
25	110	80	60

1.2.1 Insulation of wall, ceiling and floor**Type of insulation panels**

You can select among the following type of panels :

- Usual panels,
- « Complex panels »: insulation is covered with a with a cover material (plaster, mineral
- « Sandwich panels »: insulation is covered on each side with a wooden panel or plaster board.

Important: The covering of the panels **protects the insulation against damage and guarantees its longevity. Avoid using mineral fibres insulation** (glass wool, rock wool, etc...) as they may accumulate moisture and lose their insulation power and avoid also thin film insulation that are not effective for cold.

DO YOU KNOW THAT ?

Some insulating materials are damaged by rodents (mouse, rats...). If necessary, cover the insulation with a protective lining on the inside of the cellar to avoid presence of mouse or rats.

→ Polyurethane is an insulator that, due to its chemical composition, is not attacked by the rodents.

Floor insulation

The floor of the cellar must be able to support the shelves and the stored wine. Thus, it's necessary to choose insulation with adequate compression strength.

USER GUIDE WINE C25 / C25S(R)/WINEC25X/WINEC25S(R)X

Improve the load capacity of the insulation (particularly under the shelf legs) by using :

- « **Complex** » insulation panels covered by panels of higher load capacity.
- **Cover the insulation panel with a wooden panel** (at least 15 mm thickness), or every other appropriated material.

1.2.1. The door

Door improves the insulation. Two solutions are possible:

- **Insulate an existing door with the same insulation materials used for the walls of the cellar.** Provide a tight seal between the door frame and all sides of the door with a strip of foam rubber for example.
- **Use a specially WINEMASTER isothermal door** with polyurethane and a sealing foam rubber.

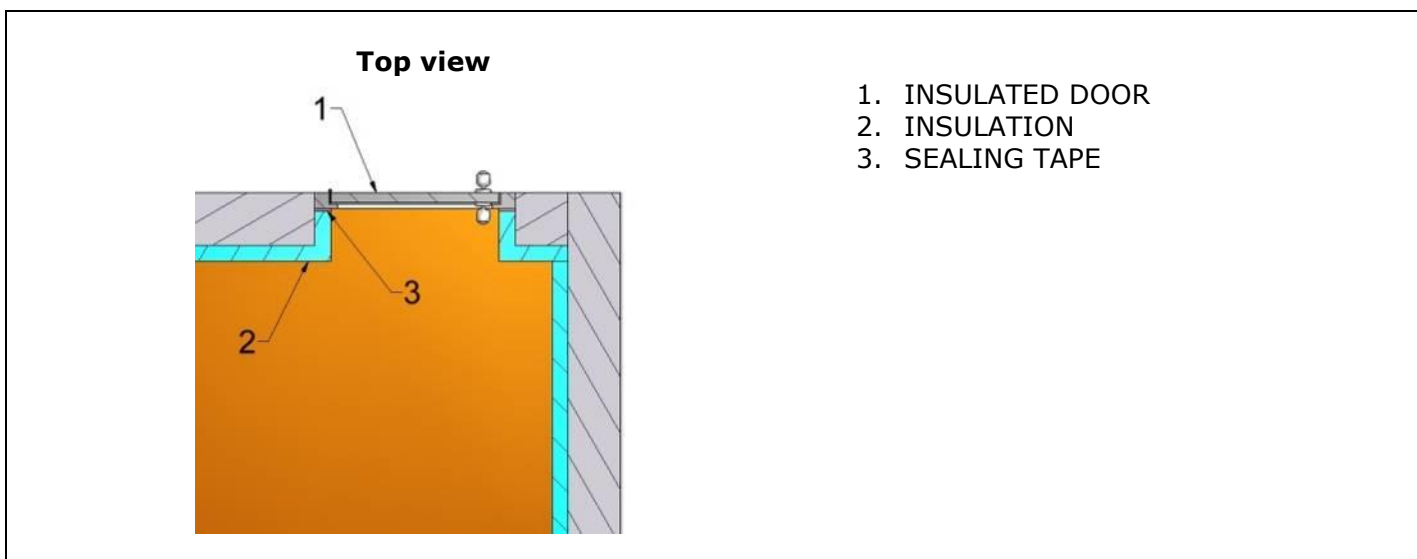

1.2.3 Insulation of other elements

Avoid placing a wine cabinet or freezer who generates heat in the cellar. **Hot water pipe from central heating** going through the cellar **have to be insulated too.**

2 INSTALLATION OF WINE CONDITIONING UNIT WINEMASTER®

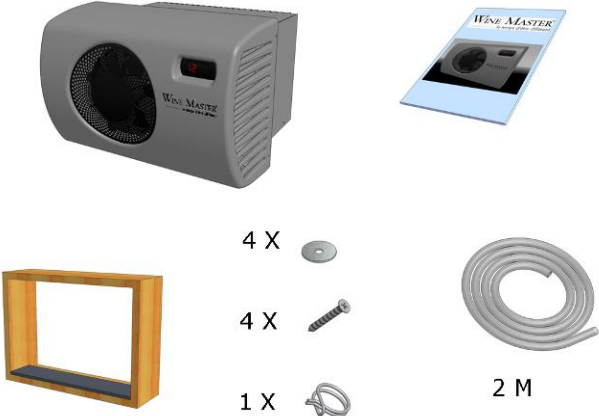

THE UNIT HAS TO BE INSTALLED RESPECTING THE NATIONAL RULES OF ELECTRIC INTALLATIONS.

	
<p>Necessary material (not supplied)</p>	<p>Supplied material</p>

2.1 Wall Drilling

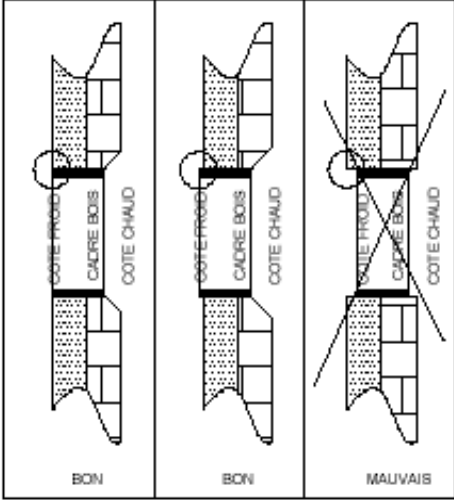
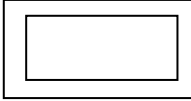
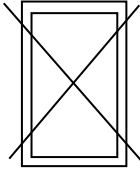

Cut the wall in order to seal the wooden frame. The cut size need to be 525 mm long and 390 mm high. Please be careful to leave at least 100 mm from the both ceiling : cellar and external.

2.2 Sealing and wooden frame levelling



<p>1</p> 	 <p>CORRECT</p>  <p>INCORRECT</p>
<ul style="list-style-type: none"> - Seal the wooden frame in order it fit flush with the inner wall of the cellar. - If the wall is thicker than the wooden frame, cut a wedge-shape in the wall (more than 220 mm) - Fill the joint between the wooden frame and the insulation - Do not put polyurethane foam between the unit and the wooden frame (for removing purpose). 	<p>The wooden frame must be level; the widest side at the horizontal</p>

2.3 Fitting the air conditioner

2.3.1. Removing the plastic cover

<p>1</p> 	<p>2</p> 
<p>Unscrew the 2 screws on each side of the air conditioner</p>	<p>Remove the cover</p>

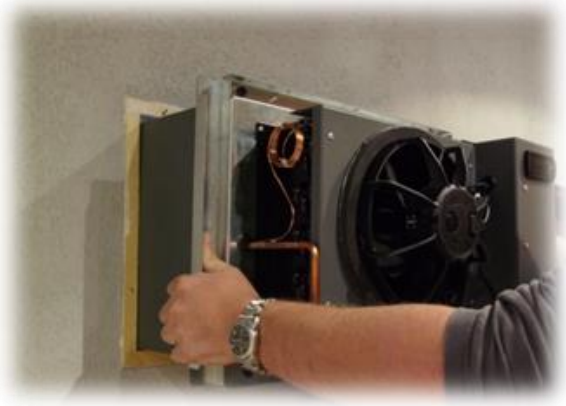
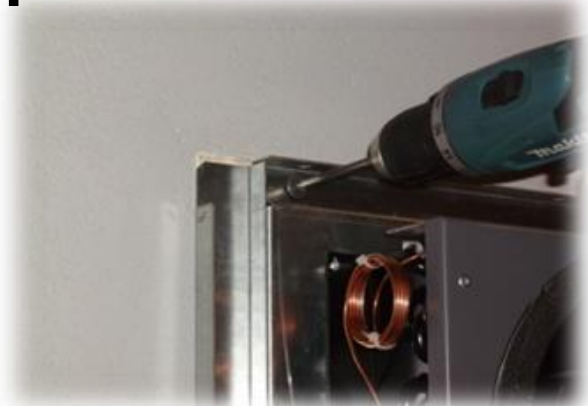
2.3.2. Fitting the device into the wooden frame

<p>3</p> 	<p>4</p> 
<p>Position the air-conditioner in the frame from inside the cellar</p>	<p>Tighten the two screw/washer units at the top</p>
<p>5</p> 	
<p>Tighten the two screw/washer units on the side</p>	

2.3.3. Installing the water drain system

The electrical connection cable and the PVC condensate drain are situated inside the cellar. Check the seal between the wooden frame and the Winemaster®.



If the power cable is damaged, it has to be replaced by the producer, his after-sale service or qualified people in order to avoid any danger.



Flow from the condensate collection tray.



Push the PVC pipe on.



Pinch the collar to open it and slide it along the pipe

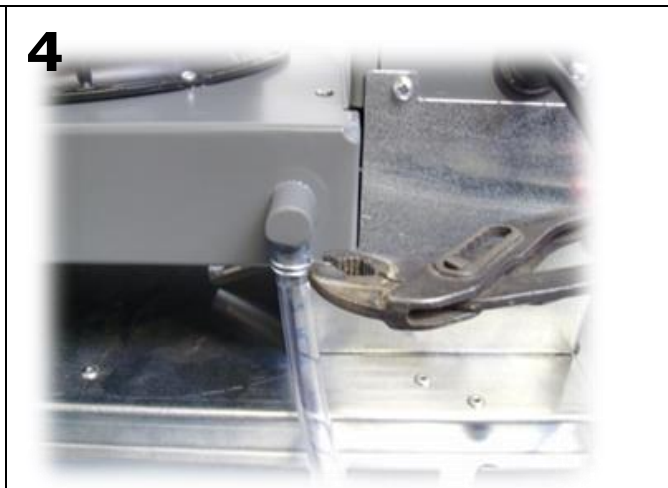

Place the collar as close to the pipe as possible

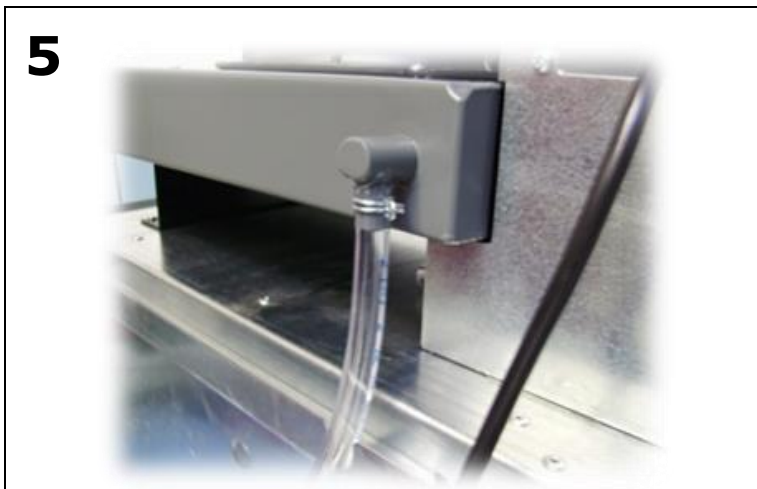

The pipe is well attached.



Refit the cover on the Winemaster and tighten the 4 screws

↩ Important :
Wait for 24 hours before plugging on the air-conditioner

3. USING THE AIR CONDITIONER WINEMASTER®

The thermostat indicates the temperature in the wine cellar with a precision of 2°C.

A temperature change of the air does not mean the same change of temperature of the liquid due to the thermal capacity of the liquid.

The temperature is set at 13° C in the factory. During installation the set temperature must be controlled and even adjusted as per following process.

3.1 Plugging the air conditioner WINE C25 / C25S(R)/WINEC25X/WINEC25S(R)X

When you plug it to the electric socket:

- the fan in the cellar starts up immediately (permanent ventilation « no frost »)
- If the temperature of the cellar is \geq as the thermostat setting, the compressor will run after 2 minute.
- If the temperature of the cellar is \leq as the thermostat setting, the compressor will not run.





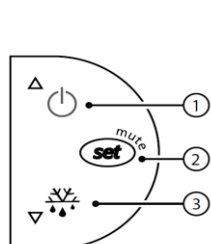

The socket has to remain easily reachable after installation.

3.2 Setting the temperature





The setting of the targeted temperature of the cellar is made on the thermostat

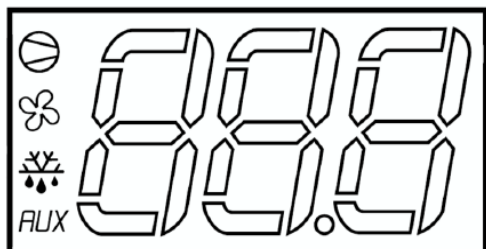

- Press button  one second until the targeted temperature is blinking.
- Use button  to increase the temperature or
- Use button  to lower the temperature.
- When the right temperature is set, press again on button  to confirm .

Explanation of the main display symbols :



- Red light  = cold mode engaged (compressor working)
- Red light  = cooling fan high speed
- Red light  = heating mode engaged (resistance: C25S /C25SR/WINEC25SX/WINEC25SRX)
- **Do not take care of this light for model C25/WINEC25X**
- Red light  and message « DF » on display = defrost engaged

3.3. Standby mode

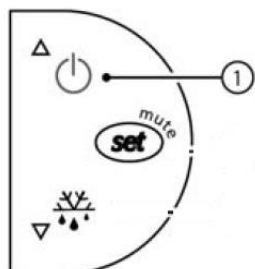

- Standby mode : maintain a 3 seconds pressure on button 1. The compressor stops and the fan turn at low speed.
- The thermostat indicates « OFF » and also the cellar temperature.
- To come back, maintain again a 3 seconds pressure on button 1.
- The thermostat indicates « ON » during 1 second.



3.4. Automatic defrost

The thermostat of models C25/C25S(R)/WINEC25X and WINEC25S(R)X will run an automatic defrost time several times a day. During this operation, the compressor is stopped, only the fan is functioning at low speed. The condensate water produced during this period will be evacuated through the tube drain. The display shows « DF » during the defrost time.

4. MAINTENANCE OF THE AIRCONDITIONER WINEMASTER®

4.3. Replacing the filter

→ A filter check is recommended every 3 months.

<p>1</p> 	<p>2</p> 
<p>It is not necessary to remove the cover in order to replace the dust filter.</p>	<p>Raise the notch to release the filter and take it out from underneath. Repeat the same operation in reverse for the replacement.</p>

IMPORTANT :



- Regular filter cleaning once every three months by vacuum cleaner
- Regular cleaning of outside grids (foliage...)
- Replace the dust filter when necessary and at least once a year

→ **DIRTY FILTER = DAMAGED WINE CONDITIONING UNIT**

5. WARRANTY

5.1 Legal warranty

The contractual warranty is not exclusive, earnings for the benefit of the purchaser profit of the legal warranty against defects or hidden defects that applies under the conditions of article 1641 and following from the customer code.

5.2 2 years contractual warranty

WINEMASTER offers a 2 years warranty against any manufactured defect.
 During this period of contractual warranty, WINEMASTER will replace any acknowledge defective part
 Les interventions et retours devront être réalisés seulement après accord écrit du service après-vente FONDIS.

In case of electric failure, WINEMASTER reserves the right to send an expert technician to inspect the appliance before replacing any defective parts.
 In case of refrigeration failure, WINEMASTER may require that the appliance is returned to the factory for repair.

5.3 Warranty conditions

The contractual warranty applies to all appliances installed and used in conformity with this « User Manual". His application is conditioned by the presentation of the purchase invoice or for lack of its copy.

5.4 Exclusions and limitations of warranty

The warranty can be refused in the following cases:

- Insulation of the cellar or installation of the appliance not in compliance with the instructions of this guide.
- Damage due to negligence, lack of maintenance or incorrect use of the WINEMASTER® (particularly dirty filters).
- Exchange or repair of parts under warranty will not extend the 2 years warranty period
- WINEMASTER cannot, in any case, be held liable for any direct or indirect damages resulting from the failure of the air conditioner. The warranty is exclusively limited to the product itself.

WINEMASTER cannot, in any case, be held liable for any direct or indirect damages resulting from the failure of the air conditioner. **The warranty is exclusively limited to the product itself.**



The European Community, attaching a great importance to the environment and the waste processing, set up Directive 2002/96/CE relating to the Electric and Electronic Component waste.

In accordance with this standard, the logo "barred dust bin" is obligatory.

This logo means that this product cannot be thrown in the household shelter. It must be given to a suitable collection point for the treatment, valorisation, recycling of Electric and Electronic components.

Acting like that you make a gesture for the environment and you contribute to the safeguarding of the natural resources as well as to the protection of human health.